

# > TIGE 6 MM / 6 MM ROD COMPONENTS



## R6100

KIT POUR FIXATION SOL-PLAFOND  
- Fixation haute Ø 18,5 mm  
- Fixation basse avec tendeur

(Clé Allen et vis fournies avec le Kit)

FLOOR / CEILING FIXING KIT

- 18,5 mm Ø top fixing  
- Floor anchor with adjusting sleeve

(Allen key and fixing screws supplied)



## R6103

KIT POUR PANNEAU SUSPENDU  
JUSQU'À 6 mm

- Fixation haute Ø 18,5 mm  
- Support suspendu pour panneau jusqu'à 6 mm

(Clé Allen et vis fournies avec le Kit)

SUSPENSION PANEL KIT FOR UP TO 6 mm

- 18,5 mm Ø top fixing  
- Suspension support for panel up to 6 mm

(Allen key and fixing screws supplied)



Kits livrés sans tige inox  
Kits delivered without stainless steel rod

# > TIGE 6 MM / 6 MM ROD COMPONENTS



## R6102

- KIT PIVOT AVEC PLATINE  
 - Platine Ø 34,5 mm  
 - Fixation haute à pivot Ø 18,5 mm  
 - Fixation basse à pivot avec tendeur  
 - Projection 32 mm

(Clé Allen et vis fournies avec le Kit)

## WALL MOUNTED SWIVEL KIT WITH PLATE

- Plate 34,5 mm Ø  
 - Top swivel fixing 18,5 mm Ø  
 - Lower swivel fixing with adjusting sleeve  
 - 32 mm projection

(Allen key and fixing screws supplied)



## R6109

- KIT PIVOT SANS PLATINE  
 Montage modulable sur rail

WALL MOUNTED SWIVEL KIT WITHOUT PLATES  
 Modular assembly on rail



## R6500

- L. 0,5 M / TIGE INOXYDABLE DE FINITION  
 - 1 Bout arrondi

L. 0,5 M / STAINLESS STEEL ROD FINISH  
 - 1 Rounded end

## R6501

- L. 1 M / TIGE INOXYDABLE  
 - Filetée et taraudée

L. 1 M / STAINLESS STEEL ROD  
 - threaded ends

## R6502

- L. 1,5 M / TIGE INOXYDABLE  
 - Filetée et taraudée

L. 1,5 M / STAINLESS STEEL ROD  
 - threaded ends



## R6405

- EMBOUT DE TIGE  
 - Finition nickelée

FINISHING END CAP  
 - Nickel-plated finish

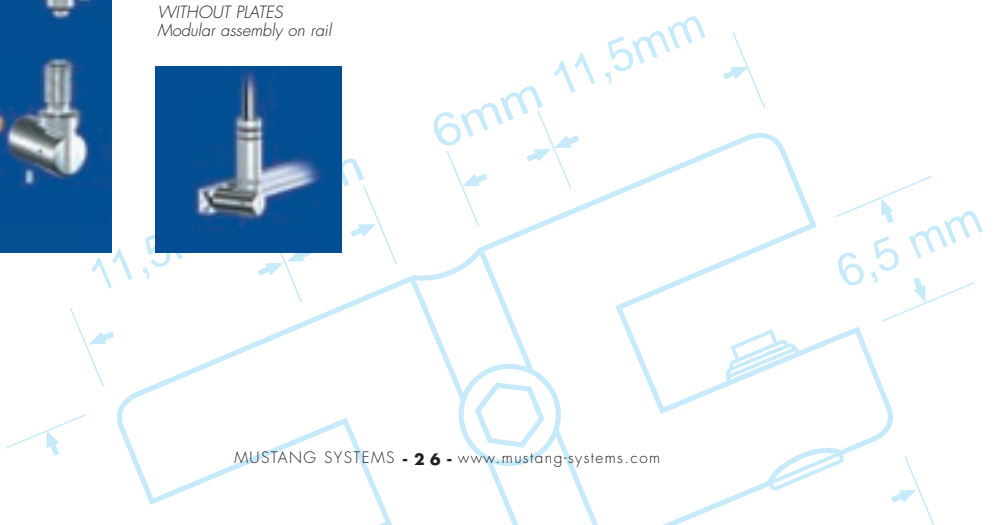

# > TIGE 6 MM / 6 MM ROD COMPONENTS



**R6104**

FIXATION MURALE SANS PLATINE  
WALL FIXING WITHOUT PLATE

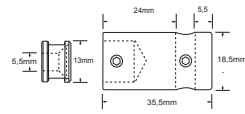

**R6105**

FIXATION MURALE AVEC PLATINE  
WALL FIXING WITH PLATE

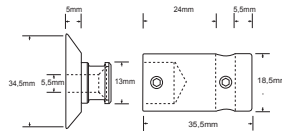

**R6110**

FIXATION MURALE LONGUE SANS PLATINE  
LONG WALL FIXING WITHOUT PLATE

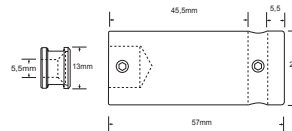

**R6111**

FIXATION MURALE LONGUE AVEC PLATINE  
LONG WALL FIXING WITH PLATE

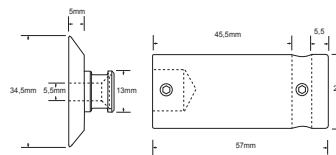

**R6101**

FIXATION PLAFOND AVEC BAGUE FILETÉE  
TOP FIXING WITH THREADED RING

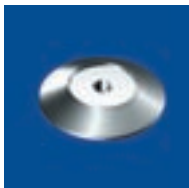
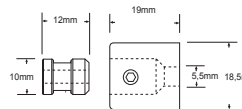

**C1702**

PLATINE DE FINITION  
FINISHING PLATE

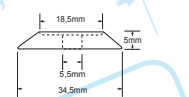

**R6406**

FIXATION HAUTE POUR TRAVERSES OU CIMAISES  
AVEC BAGUE FILETÉE  
TOP FIXING FOR OVERHEAD RAIL OR CROSS BAR  
WITH THREADED RING

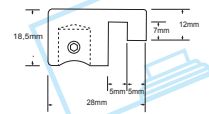

# > TIGE 6 MM / 6 MM ROD COMPONENTS

6 mm



**R6201**

SUPPORT POUR PANNEAU JUSQU'A 6 mm

PANEL SUPPORT FOR UP TO 6 mm

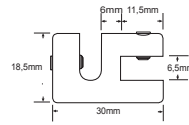

**R6203**

SUPPORT DOUBLE POUR PANNEAU JUSQU'A 6 mm

TWIN PANEL SUPPORT FOR UP TO 6 mm

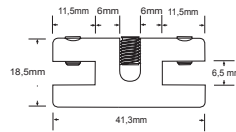

10 mm



**R6202**

SUPPORT POUR PANNEAU JUSQU'A 10 mm

PANEL SUPPORT FOR UP TO 10 mm

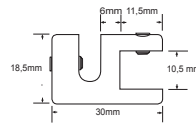

**R6204**

SUPPORT DOUBLE POUR PANNEAU JUSQU'A 10 mm

TWIN PANEL SUPPORT FOR UP TO 10 mm

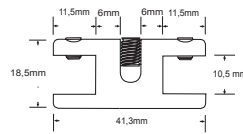

**R6401**

SUPPORT SUPERIEUR OU INFERIEUR  
POUR PANNEAU JUSQU'A 10 mm

PANEL SUPPORT TOP OR BOTTOM  
FOR UP TO 10 mm

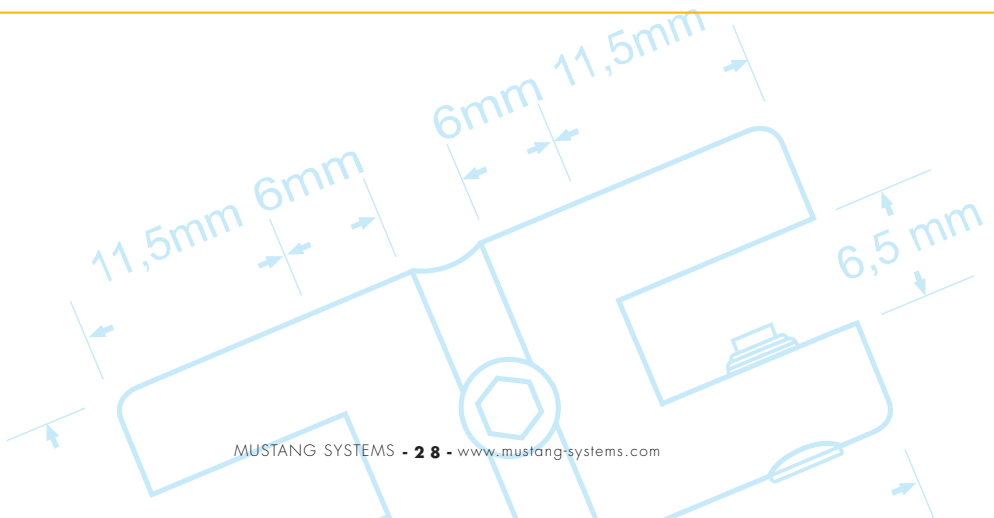
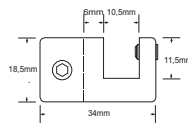

# > TIGE 6 MM / 6 MM ROD COMPONENTS



**R6300**

SUPPORT POUR TABLETTE PERCEE / PERÇAGE Ø 10 mm

PIERCED SHELF SUPPORT / 10 mm Ø HOLE FIX

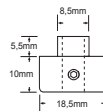

**R6301**

SUPPORT POUR TABLETTE JUSQU'A 6 mm

SHELF SUPPORT FOR UP TO 6 mm

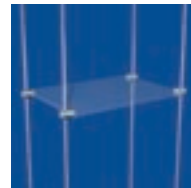
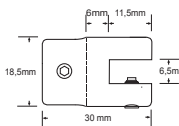

**R6303**

SUPPORT DOUBLE POUR TABLETTE JUSQU'A 6 mm

TWIN SHELF SUPPORT FOR UP TO 6 mm

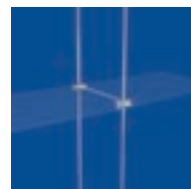
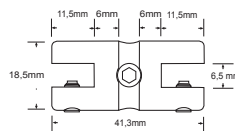

**R6302**

SUPPORT POUR TABLETTE JUSQU'A 10 mm

SHELF SUPPORT FOR UP TO 10 mm

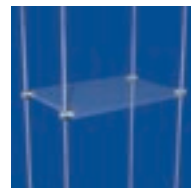
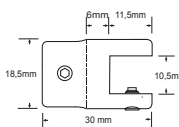

**R6304**

SUPPORT DOUBLE POUR TABLETTE JUSQU'A 10 mm

TWIN SHELF SUPPORT FOR UP TO 10 mm

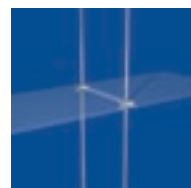
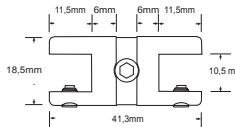

**R6306**

CONSOLE POUR TABLETTE JUSQU'A 8 mm  
- Finition Aluminium brossé / épaisseur 2 mm

SHELF CONSOLE FOR UP TO 8 mm  
- Brushed Aluminium finish / 2 mm thickness

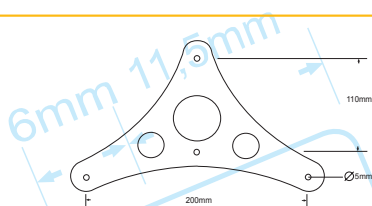

6 mm

10 mm

8 mm

# > TIGE 6 MM / 6 MM ROD COMPONENTS

8 mm



**R6600**

SUPPORT ORIENTABLE POUR LUTRIN, PANNEAU ET TABLETTE JUSQU'A 8 mm

SWIVEL LECTURN, PANEL AND SHELF SUPPORT FOR UP TO 8 mm

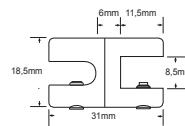

**R6601**

SUPPORT DOUBLE ORIENTABLE POUR LUTRIN, PANNEAU ET TABLETTE JUSQU'A 8 mm

TWIN SWIVEL LECTURN, PANEL AND SHELF SUPPORT FOR UP TO 8 mm

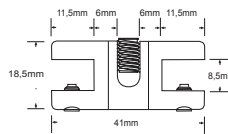

Pour bloquer l'orientation, supprimer la bague en laiton.

To prevent the rotation of the support, remove the brass ring.

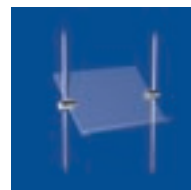

**R6400**

SUPPORT DE CADRE

FRAME SUPPORT

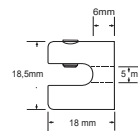

de 4 à 6 mm



**R6407**

SUPPORT POUR PANNEAU PERCE / PERÇAGE Ø 5 mm

PIERCED PANEL SUPPORT / 5 mm Ø HOLE FIX

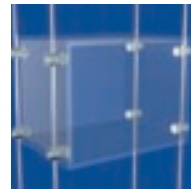
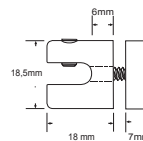

**R6409**

SUPPORT DOUBLE POUR PANNEAU PERCE / PERÇAGE Ø 5 mm

TWIN PIERCED PANEL SUPPORT / 5 mm Ø HOLE FIX

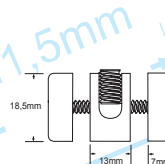

# > TIGE 6 MM / 6 MM ROD COMPONENTS



## R6404

TUBE HORIZONTAL & 2 SUPPORTS L. 1 MÈTRE  
 - Tube Ø 16 mm  
 - Finition Aluminium anodisé

HORIZONTAL TUBE & 2 SUPPORTS / L. 1 METRE  
 - 16 mm Ø tube  
 - Anodized Aluminium finish

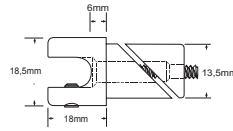

Autres dimensions : nous consulter / Other dimensions : consult us



## R6410

BARRE PENDERIE / 1 MÈTRE  
 - Tube Ø 25 mm / 2 bagues d'arrêt / 2 embouts de finition  
 - Finition Acier chromé

HANGING RAIL / L. 1 METRE  
 - 25 mm Ø tube / 2 cable-grips / 2 finishing caps  
 - Steel chrome finish

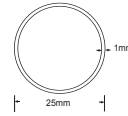

Autres dimensions : nous consulter / Other dimensions : consult us



## R6403

SUPPORT CROCHET INOX

HOOK SUPPORT

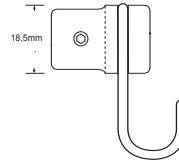

## R6408

SUPPORT DOUBLE CROCHET INOX

TWIN HOOK SUPPORT

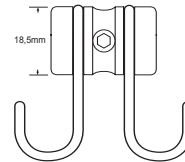

## R6712

DISQUE CACHE-PLAFOND

CEILING SHIELD



## C1710

FIXATION POUR RAIL (M 4)

RAIL SUPPORT (M 4)

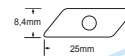

## C1711

RAIL POUR FIXATION SOL-PLAFOND (2 MÈTRES)  
 - Finition Aluminium anodisé

FLOOR / CEILING FIXING RAIL (2 METRES)  
 - Anodized Aluminium finish

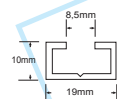

Pour implantation modulable / For modular set up



**601**  
 PORTE-LUNETTES  
 - Finition dépolie  
 EYE-GLASSES HOLDER  
 - Frosted finishing

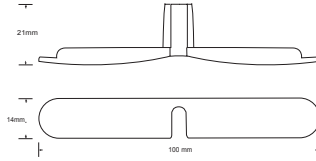

**R6508**  
 TIGE COUDEE INOXYDABLE Ø 6 mm  
 STAINLESS STEEL BENDED ROD 6 mm Ø

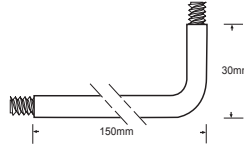

**R6713**  
 CONNECTION 90° TIGE / TIGE  
 90° CONNEXION ROD / ROD

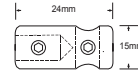

**R6101**  
 FIXATION AVEC BAGUE FILETÉE  
 TOP FIXING WITH THREADED RING

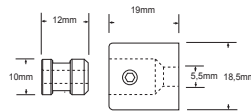

**R6500**  
 L. 0,5 M / TIGE INOXYDABLE DE FINITION  
 - 1 Bout arrondi

L. 0,5 M / STAINLESS STEEL ROD FINISH  
 - 1 Rounded end

**R6501**  
 L. 1 M / TIGE INOXYDABLE  
 - Filetée et taraudée

L. 1 M / STAINLESS STEEL ROD  
 - threaded ends

**R6502**  
 L. 1,5 M / TIGE INOXYDABLE  
 - Filetée et taraudée

L. 1,5 M / STAINLESS STEEL ROD  
 - threaded ends



Compatible gamme Tige Ø 6 mm  
 Compatible with 6 mm Ø rod components